AIWA

COMPACT DISC STEREO SYSTEM

XR-M55



OPERATING INSTRUCTIONS



For assistance and information,
call toll free 1-800-BUY-AIWA.
(United States and Puerto Rico)

8Z-CL6-901-01
981110AWW-X6

ENGLISH **pg. 1**

WARNING

TO REDUCE THE RISK OF FIRE OR ELECTRIC SHOCK, DO NOT EXPOSE THIS APPLIANCE TO RAIN OR MOISTURE.



"CAUTION : TO REDUCE THE RISK OF ELECTRICAL SHOCK, DO NOT REMOVE COVER (OR BACK). NO USER-SERVICEABLE PARTS INSIDE. REFER SERVICING TO QUALIFIED SERVICE PERSONNEL."

Explanation of Graphical Symbols:



The lightning flash with arrowhead symbol, within an equilateral triangle, is intended to alert the user to the presence of uninsulated "dangerous voltage" within the product's enclosure that may be of sufficient magnitude to constitute a risk of electric shock to persons.



The exclamation point within an equilateral triangle is intended to alert the user to the presence of important operating and maintenance (servicing) instructions in the literature accompanying the appliance.

PRECAUTIONS

Read the Operating Instructions carefully and completely before operating the unit. Be sure to keep the Operating Instructions for future reference. All warnings and cautions in the Operating Instructions and on the unit should be strictly followed, as well as the safety suggestions below.

Installation

1 Water and moisture - Do not use this unit near water, such as near a bathtub, washbowl, kitchen sink, laundry tub, in a wet basement, swimming pool, or the like.

2 Heat - Do not use this unit near sources of heat, including heating vents, stoves, or other appliances that generate heat.

It also should not be placed in temperatures less than 5°C (41°F) or greater than 35°C (95°F).

3 Mounting surface - Place the unit on a flat, even surface.

4 Ventilation - The unit should be situated with adequate space around it so that proper heat ventilation is assured. Allow 10 cm (4 in.) clearance from the rear and the top of the unit and 5 cm (2 in.) from each side.

- Do not place the unit on a bed, rug, or similar surface that may block the ventilation openings.

- Do not install the unit in a bookcase, cabinet, or airtight rack where ventilation may be impeded.

5 Objects and liquid entry - Take care that objects or liquids do not get inside the unit through the ventilation openings.



6 Carts and stands - When placed or mounted on a stand or cart, the unit should be moved with care. Quick stops, excessive force, and uneven surfaces may cause the unit or cart to overturn or fall.

7 Condensation - Moisture may form on the CD pickup lens when:

- the unit is moved from a cold spot to a warm spot

- the heating system has just been turned on

- the unit is used in a very humid room

- the unit is cooled by an air conditioner

When this unit has condensation inside, it may not function normally. Should this occur, leave the unit for a few hours, then try to operate again.

8 Wall or ceiling mounting - The unit should not be mounted on a wall or ceiling, unless specified in the operating instructions.

Electric Power

1 Power sources - Connect this unit only to power sources specified in the Operating Instructions, and as marked on the unit.

2 Polarization - As a safety feature, some units are equipped with polarized AC power plugs which can only be inserted one way into a power outlet. If it is difficult or impossible to insert the AC power plug into an outlet, turn the plug over and try again. If it still does not easily insert into the outlet, please call a qualified service technician to service or replace the outlet. To avoid defeating the safety feature of the polarized plug, do not force it into a power outlet.

3 AC power cord

- When disconnecting the AC power cord, pull it out by the AC power plug. Do not pull the cord itself.

- Never handle the AC power plug with wet hands, as this could result in fire or shock.

Do not walk on the power cord or pinch it by items placed upon or against it, as these could result in fire or shock.

- Avoid overloading AC power plugs and extension cords beyond their capacity, as this could result in fire or shock.

PRECAUTIONS (cont) pg. 2

4 **Extension cord** - To help prevent electric shock, do not use a polarized AC power plug with an extension cord, receptacle, or other outlet unless the polarized plug can be completely inserted to prevent exposure of the blades of the plug.

5 **Nonuse periods** - Unplug the AC power cord from the AC power plug if the unit will not be used for several months or more. When the cord is plugged in, a small amount of current continues to flow to the unit, even when the power is turned off.

Outdoor Antenna

1 **Power lines**- When connecting an outdoor antenna, make sure it is located away from power lines.

2 **Outdoor antenna grounding**- Be sure the antenna system is properly grounded to provide protection against unexpected voltage surges or static electricity build-up. Article 810 of the National Electric Code, ANSI/NFPA70, provides information on proper grounding of the mast, supporting structure, and the lead-in wire to the antenna discharge unit, as well as the size of the grounding unit, connection to grounding terminals, and requirements for grounding terminals themselves.

Maintenance

Clean the unit only as recommended in the Operating Instructions.

Damage Requiring Service

Have the units serviced by a qualified service technician if:

- The AC power cord or plug has been damaged
- Objects or liquid have gotten inside the unit
- The unit has been exposed to rain or water
- The unit does not seem to operate normally
- The unit exhibits a marked change in performance
- The unit has been dropped, or the cabinet has been damaged

DO NOT ATTEMPT TO SERVICE THE UNIT YOURSELF

Owner's record

For your convenience, record the model number and serial number (you will find them on the rear of your set) in the space provided below. Please refer to them when you contact your Aiwa dealer in case of difficulty.

Model No. Serial No. (Lot No.)
XR-M55 U

TABLE OF CONTENTS

PRECAUTIONS	1
PREPARATIONS	
CONNECTIONS	3
REMOTE CONTROL	5
BEFORE OPERATION	5
SOUND	
AUDIO ADJUSTMENTS	7
GRAPHIC EQUALIZER	7
RADIO RECEPTION	
MANUAL TUNING	8
PRESETTING STATIONS	8
CD PLAYING	
BASIC OPERATIONS	9
PROGRAMMED PLAY	10

TAPE PLAYBACK	
BASIC OPERATIONS	11
RECORDING	
BASIC RECORDING	12
AI EDIT RECORDING	13
PROGRAMMED EDIT RECORDING	14
CLOCK AND TIMER	
SETTING THE CLOCK	15
SETTING THE SLEEP TIMER	15
SETTING THE TIMER	16
OTHER CONNECTIONS	
CONNECTING OPTIONAL EQUIPMENT	17
LISTENING TO EXTERNAL SOURCES	17
GENERAL	
CARE AND MAINTENANCE	18
TROUBLESHOOTING GUIDE	18
SPECIFICATIONS	19
PARTS INDEX	20

PREPARATIONS pg. 3

CONNECTIONS

Check your system accessories



XR-M55
Compact disc
stereo cassette receiver

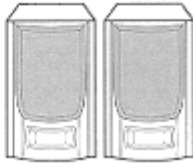

Speakers (L,R)



Remote control



FM antenna



AM antenna

Operating Instructions, etc.

Before connecting the AC cord

The rated voltage of your unit shown on the rear panel is 120 V AC. Check that the rated voltage matches your local voltage.

IMPORTANT

- Connect the speakers, antennas, and all optional equipment first. Then connect the AC cord in the end.
- There are no differences between the front speakers. Both speakers can be connected as L (left) or R (right)

1 Connect the right speaker to the main unit.

(1) Connect the speaker cord with the plug to the SPEAKERS HIGH FREQ R terminal.



(2) Connect the speaker cord with the white stripe to the SPEAKERS LOW FREQ R + terminal and the black cord to the - terminal.

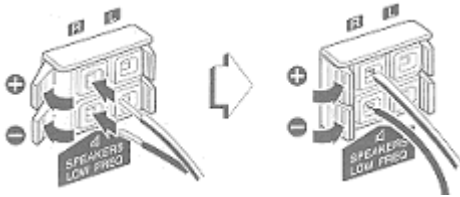

2 Connect the left speaker to the main unit.

Connect the speaker cord with plug to the SPEAKERS HIGH FREQ L terminal, and another speaker cord to the SPEAKERS LOW FREQ L terminals in the same manner as step 1.

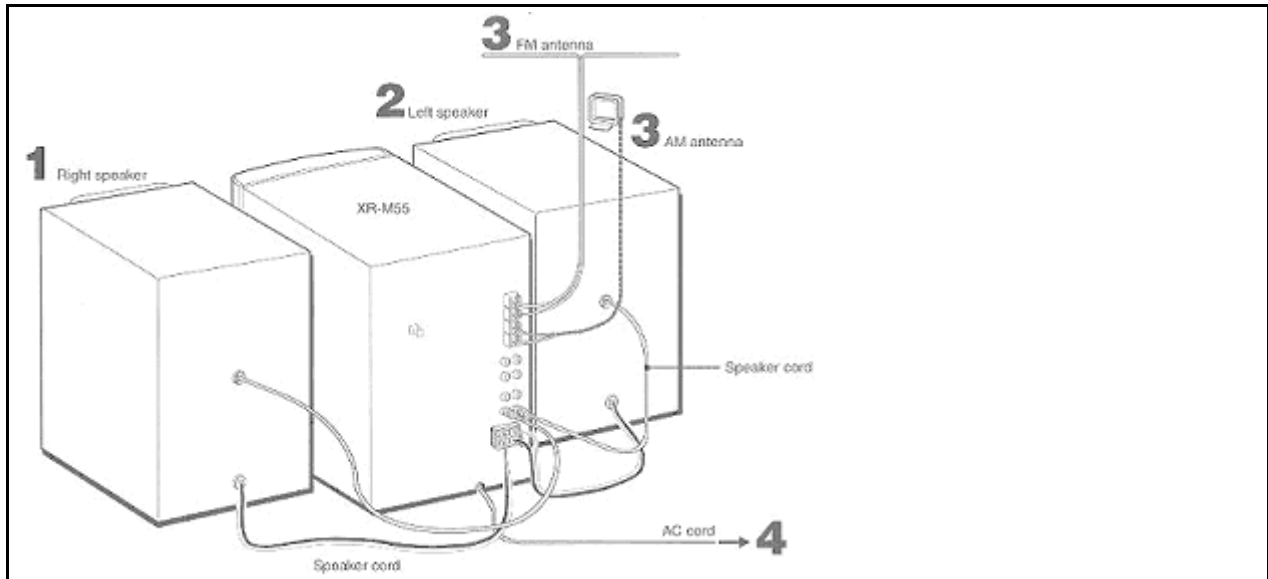

PREPARATIONS (cont) pg. 4

3 Connect the supplied antennas.

Connect the FM antenna to **FM 75 Ω** terminals and the AM antenna to **AM LOOP** terminals.

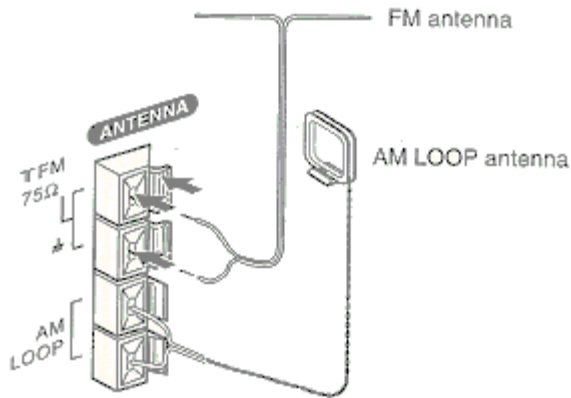

4 Connect the AC cord to an AC outlet.

To stand the AM loop antenna on a surface

Fix the claw to the slot.

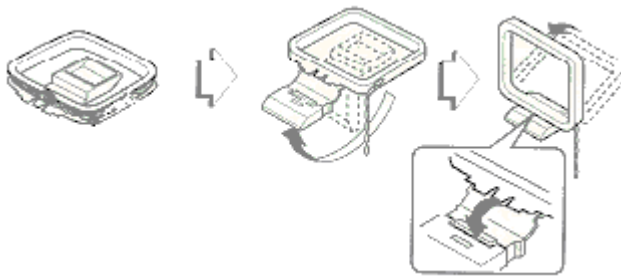

To position the antennas

FM feeder antenna:

Extend this antenna horizontally in a T-shape and fix its ends to the wall.

AM loop antenna:

Position for the best reception.

Note

- Do not connect any speakers to the unit other than the supplied ones.
- Be sure to connect the speaker cords correctly. Improper connections can cause short circuits in **SPEAKERS** terminals.

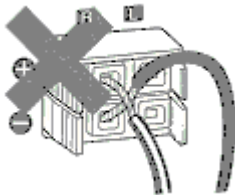

- Do not leave objects generating magnetism, such as credit cards, near the speakers, as these objects may be damaged.
- Do not bring the FM antenna near metal objects or curtain rails.
- Do not bring the AM antenna near other optional equipment, the stereo system itself, the AC cord or speaker cords, since noise will be picked up.

- Do not unwind the AM antenna wire.

CONNECTING AN OUTDOOR ANTENNA

For better FM reception, use of an outdoor antenna is recommended.
Connect the outdoor antenna to **FM 75 Ω** terminals.

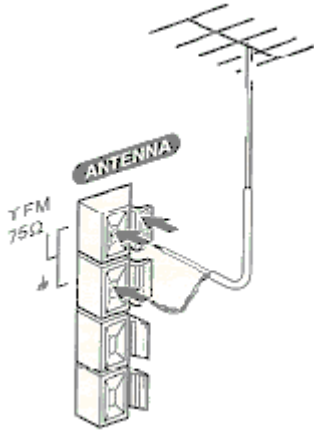

To connect other optional equipment --> page 17

PREPARATIONS (cont) pg. 5

REMOTE CONTROL

Inserting batteries

Detach the battery cover on the rear of the remote control and insert two size AA (R6) batteries.

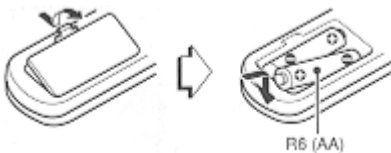

When to replace the batteries

The maximum operational distance between the remote control and the sensor on the main unit should be approximately 5 meters (16 feet). When this distance decreases, replace the batteries with new ones.

Using the remote control

The instructions in this manual refer mainly to the buttons on the main unit. Buttons on the remote control with the same names as those on the main unit can be used as well.

To use FUNCTION on the remote control

The **FUNCTION** substitutes for the function buttons (**TAPE, TUNER, VIDEO/AUX, CD, MD**) on the main unit. Each time **FUNCTION** is pressed while power is on, the next function is selected cyclically.

▶ **PLAY** on the remote control

The function is the same as that of ◀▶ on the main unit.

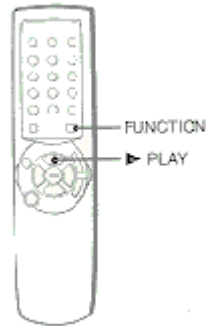

NOTE

- If the remote control is not going to be used for an extended period of time, remove the batteries to prevent possible electrolyte leakage.
- The remote control may not operate correctly when:
 - The line of sight between the remote control and the remote sensor above **DEMO/ECO** is exposed to intense light, such as direct sunlight
 - Other remote controls are used nearby (those of a television, etc.)

BEFORE OPERATION

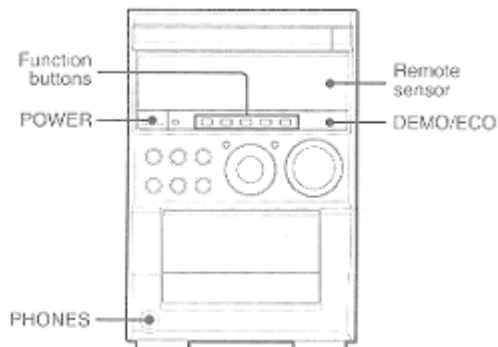

To turn the unit on

Press one of the function buttons (**TAPE, TUNER, VIDEO/AUX, CD, MD**). Playback of the inserted disc or tape begins, or the previously tuned station is received (Direct Play Function).

POWER is also available.

To turn the power off

Press **POWER**. When the clock is set, the unit will return to the ECO mode or clock display depending on the setting before you turn on the unit.

If the previous setting is DEMO, the unit will also return to the clock display.

- If the clock is not set, the unit will always return to the DEMO mode.

DEMO (Demonstration) mode

When the AC cord is connected, the display window demonstrates the functions of the unit. When the power is turned on, the DEMO display is overridden by the operation display.

To cancel (Demonstration) mode

Press **DEMO/ECO**.

To re-activate the DEMO mode, press **DEMO/ECO** until the display window demonstrates the functions of the unit.

To change the brightness of the display

Press **DEMO/ECO** twice during power on.

The display is dimmer than usual, press **DEMO/ECO** again to restore normal display.

Using the headphones

Connect the headphones to **PHONES** jack with a stereo mini plug (ø3.5 mm, 1/8 inch).

No sound is output from the speakers while the headphones are plugged in.

PREPARATIONS (cont) pg. 6

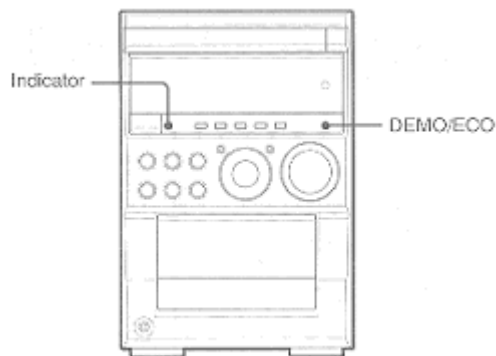

SETTING ECO (POWER ECONOMIZING) MODE

Setting this unit to power economizing mode reduces power consumption.

Press **DEMO/ECO** repeatedly (during power off) until "ECO MODE" is displayed.

The display disappears and the indicator beside the **POWER** lights up.

4-Channel Multi-Amplifier System

To provide reinforcement for the ultra-low frequencies, in addition to the Left/Right 2-channel amplifier used to reproduce mid-to-high-range frequencies (200Hz - 20 kHz), this system incorporates a second L/R 2-channel amplifier just for reproduction of ultra-low frequencies - making it, in effect, a 4-amplifier system. By utilizing discrete amplifiers for mid-to-high-frequencies and low frequencies, high quality sonic reproduction that is virtually free from distortion can be realized.

This Multi Amplifier System, which utilizes independent circuitry for the different frequency ranges, enables superb sonic reproduction free from distortion.

Built-in Subwoofer System

The built-in subwoofer System has a separate subwoofer cavity area that is part of the loudspeaker cabinet structure, which acts as a sonic filter to cut distortion components. (In the Multi Amplifier System, the ultra-low frequency signals transmitted from their own independent amplifier are reproduced in this area.) This separate construction gives a clear, rich definition to bass reproduction and it can realize clear, well-defined mid-to-high frequency signals. And AIWA's built-in subwoofer system incorporates a subwoofer capable of powerful, satisfying bass performance

with true stereo separation.

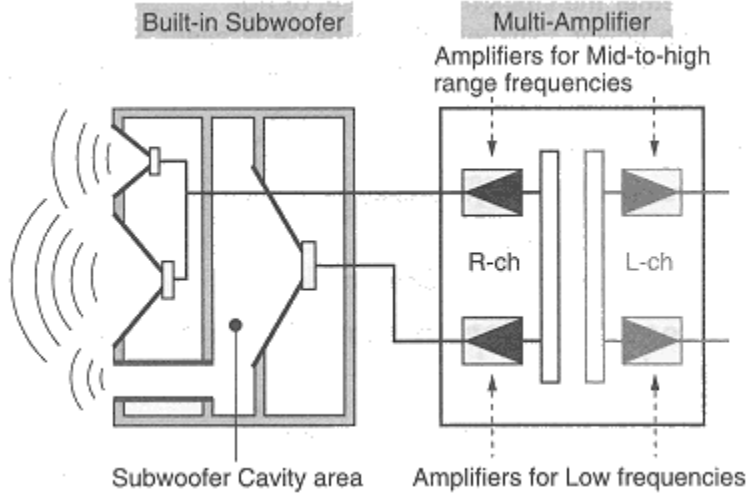

SOUND pg. 7

AUDIO ADJUSTMENTS



VOLUME

Turn VOLUME/MULTI JOG on the main unit, or press VOL (∧ or ∨) on the remote control.

The volume level is displayed as a number from 0 to MAX (31).

The volume level is automatically set to 20 when the power is turned off with the volume level set to 21 or more.

To see the present volume level press **DISPLAY** on the remote control twice.

SUPER T-BASS SYSTEM

The T-BASS system enhances the realism of low-frequency sound.

Press JOG MODE once, then turn MULTI JOG within 3 seconds to change the T-Bass level.

The level changes as follows. Select one of the three levels or the off position to suit your preference

T - BASS 0 ↔ T - BASS 1 ↔ T - BASS 2 ↔ T - BASS 3

(off)

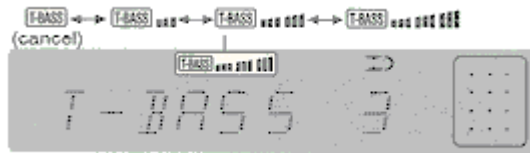

NOTE

Low frequency sound maybe distorted when the T-BASS system is used for a disc or tape in which low frequency sound is originally emphasized. In this case, cancel the T-BASS system.

GRAPHIC EQUALIZER

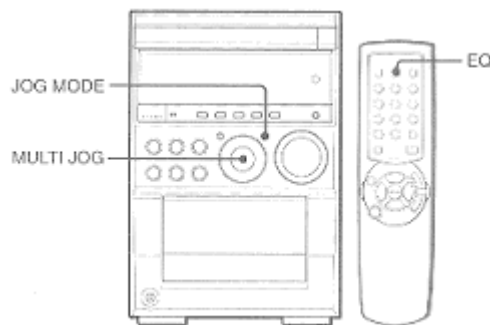

This unit provides the following three different equalization curves.

ROCK: Powerful sound emphasizing treble and bass

POP: More presence in the vocals and midrange

JAZZ: Accented lower frequencies for jazz-type music

Press JOG MODE repeatedly until "GEQ" is displayed, then turn MULTI JOG within 3 seconds to select an equalization curve.

The equalization mode is displayed. as follows:



To cancel the selected mode

Press JOG MODE repeatedly until "GEQ" is displayed, then turn MULTI JOG within 3 seconds until "GEQ OFF" is displayed.

To select with the remote control

Press EQ repeatedly. The GEQ mode is displayed cyclically as follows.



RADIO RECEPTION pg. 8

MANUAL TUNING



1 Press TUNER/BAND repeatedly to select the desired band.



When **TUNER/BAND** is pressed while the power is off, the previously tuned station will be played (Direct Play Function).

To select a band with the remote control

Press **BAND** repeatedly.

2 Press ◀◀ or ▶▶ to select a station.

Each time the button is pressed, the frequency changes. When a station is received, "TUNE" is displayed for 2 seconds. During FM stereo reception, "Ⓢ" is displayed.



To search for a station quickly (Auto Search)

Keep ◀◀ or ▶▶ pressed until the frequency starts to change rapidly. After tuning in to a station, the search stops.

To stop the Auto Search manually, press ◀◀ or ▶▶.

- The Auto Search may not stop at stations with very weak signals.

When an FM stereo broadcast contains noise

Press **MODE** on the remote control so that "MONO" appears on the display.

Noise is reduced, although reception is monaural.

To restore stereo reception, press **MODE** so that "MONO" disappears.

To change the AM tuning interval

The default setting of the AM tuning interval is 10 kHz/step. If you use this unit in an area where the frequency allocation system is 9 kHz/step, change the tuning interval.

Press **POWER** while pressing ◀▶ **DIR/ PRESET** during power on.

To reset the interval, repeat this procedure.

NOTE

When the AM tuning interval is changed, all preset stations are cleared. The preset stations have to be set again.

PRESETTING STATIONS

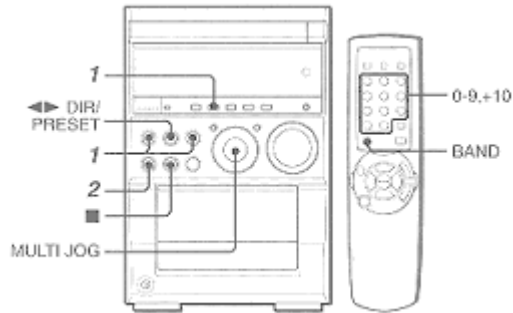

The unit can store a total of 32 preset stations (Each band has a maximum of 20 available preset stations). When a station is stored, a preset number is assigned to the station. Use the preset number to tune in to a preset station directly.

1 Press TUNER/BAND to select a band, and press ◀◀ or ▶▶ to select a station.

2 Press || to store the station.

A preset number beginning from 1 in consecutive order for each band is assigned to the station.

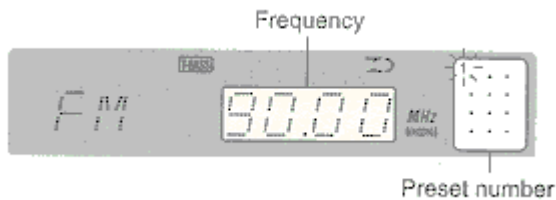

3 Repeat steps 1 and 2.

The next station will not be stored if a total of 32 preset stations for all the bands or a total of 20 preset stations for one band have already been stored.

PRESET NUMBER TUNING

Use the remote control to select the preset number directly.

1 Press BAND to select a band.

2 Press numbered buttons 0-9 and +10 to select preset number.

Example:

To select preset number 20, press +10, +10 and 0.

To select preset number 15, press +10 and 5.

Selecting a preset number on the main unit

Press TUNER/BAND to select a band. Then, press ◀▶ DIR/PRESET repeatedly or turn MULTI JOG.

Each time ◀▶ DIR/PRESET is pressed, the next ascending number is selected.

To clear a preset station

Select the preset number of the station to be cleared. Then, press ■, and press || within 4 seconds. The preset numbers of all other stations in the band with higher numbers are also decreased by one.

CD PLAYING pg. 9

BASIC OPERATIONS

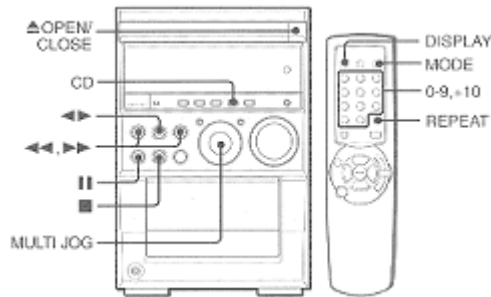

LOADING DISC

Press CD, then press CD ▲ OPEN/CLOSE to open the disc compartment. Load a disc with the label side up. Close the disc compartment by pressing CD ▲ OPEN/CLOSE.

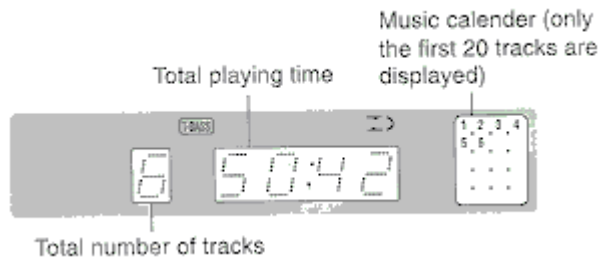
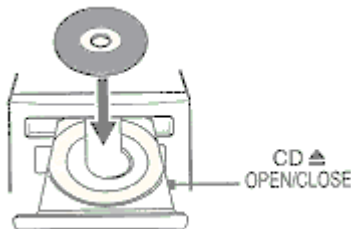

PLAYING DISC

Load a disc.

Press ▶▶.

Play begins with the first track.

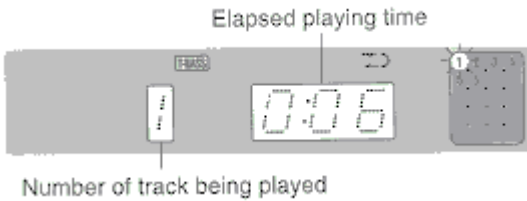

To stop play, press ■ .

To pause play, press || . To resume play, press again.

To search for a particular point during playback, keep ◀◀ or ▶▶ pressed and release it at the desired point.

To skip to the beginning of a track during playback, press ◀◀ or ▶▶ repeatedly.

To remove disc, press ▲ OPEN/CLOSE.

To start play when the power is off (Direct Play Function)

Press CD. The power is turned on and play of the loaded disc begins.

When ▲ OPEN/CLOSE is pressed, the power is also turned on and the disc compartment is opened.

To check the remaining time

During play, press DISPLAY thrice on the remote control. The amount of time remaining until all tracks finish playing is displayed. Press DISPLAY again to restore the playing time display.

Selecting a track with the remote control

Press numbered buttons 0-9 and +10 to select a track.

Example:

To select the 25th track, press +10, +10 and 5.

To select the 10th track, press +10 and 0.

The selected track starts to play and continues to the end of that disc.

NOTE

- When removing the disc, press ■ to stop play before pressing ▲ OPEN/CLOSE.
- When loading an 8-cm (3-inch) disc, put it onto the inner circle of the tray.
- Do not place more than one compact disc on the disc tray.
- Do not tilt the unit with disc loaded. Doing so may cause malfunctions.

RANDOM/REPEAT PLAY

RANDOM play

All the tracks on the disc can be played randomly.

Press MODE on the remote control until "RANDOM" lights up on the display.

To cancel random, press the button once during play mode or press the button four times during stop mode.

NOTE

- During random play, it is not possible to skip to the previously played track with ◀◀.
- During random play, direct selection of the tracks with the numbered buttons will cancel random play.
- During random play, "◀ 1" play cannot be performed and remaining time cannot be checked.

REPEAT play



One or all the tracks can be played repeatedly.

To repeat the entire disc, turn on "  ".

To repeat the desired track, turn on "  1 ".

Press REPEAT on the remote control.



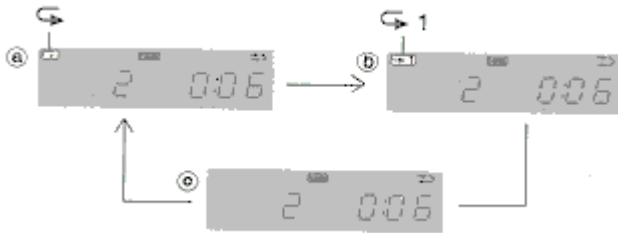

Each time **REPEAT** is pressed, the operations can be selected cyclically.

- (a) 
- (b)  1
- (c) Cancel

(a)



NOTE

- During "  " play, random play can be performed.
- When you start random play during "  1 " play, the repeat play will be canceled.
- To repeat only selected tracks, program the desired tracks (see below) before choosing "  " function.
- During "  " play or "  1 " play, remaining time cannot be checked.

PROGRAMMED PLAY

Up to 30 tracks can be programmed from the inserted disc.

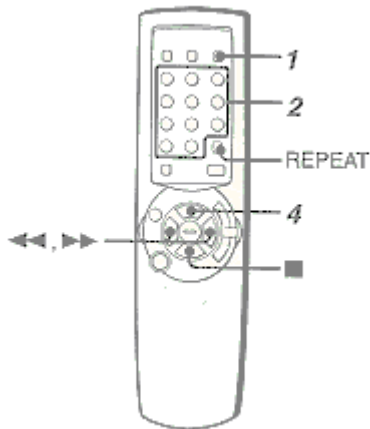

Use the remote control.

1 Press MODE repeatedly in stop mode until "PRGM" appears on the display.
"PRGM" flashes on the display.

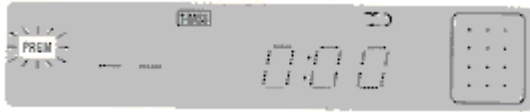

2 Press numbered buttons 0-9 and +10 to program a track.

Example:

To select the 12th track, press **+10** and **2**.

To select the 20th track, press **+10**, **+10** and **0**.

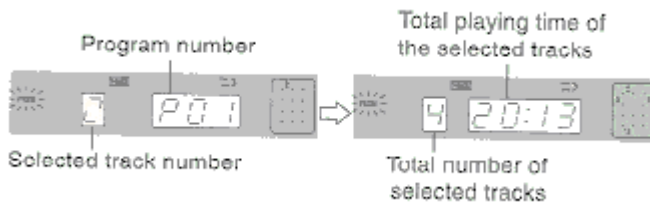

3 Repeat step 2 to program other tracks.

4 Press ► to start play.

To check the program

Each time ◀◀ or ▶▶ is pressed in stop mode, a track number and program number will be displayed.

- MULTI JOG is also available instead of ◀◀ or ▶▶.

To clear the program

Press ■ in stop mode.

To add tracks to the program

Before playing, repeat step 2. The track will be programmed after the last track.

To change the programmed tracks

Clear the program and repeat all the steps again.

To play the programmed tracks repeatedly

After programming the tracks, press **REPEAT** on the remote control, "⏮" lights up on the display.

NOTE

- During programmed play, the following operations cannot be performed:
 - Random play.
 - One-track repeat (⏮ 1).
 - Checking the remaining time.
 - Selecting a track.
- If programmed time is more than 99:59 minutes, or the disc track number 31 and above is programmed, total playing time is shown as --:-- in the display.



INSERTING A TAPE

- You can select a reverse mode to playback one or both sides.
- Use Type I (normal) tapes for playback.

Press **TAPE/REV MODE** and press **EJECT** mark to open the cassette holder

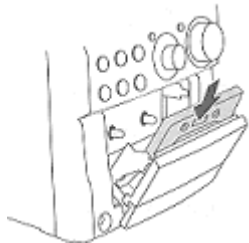

Insert a tape with the exposed side down. Push the cassette holder to close.

To select a reverse mode

Each time **TAPE/REV MODE** is pressed, the reverse mode changes.

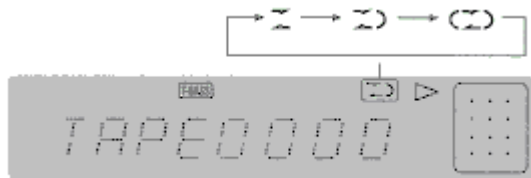

To play one side only, select

To play from front side to back side once only, select

To play both sides repeatedly, select

PLAYING BACK A TAPE

Insert a tape. Then press to start play.

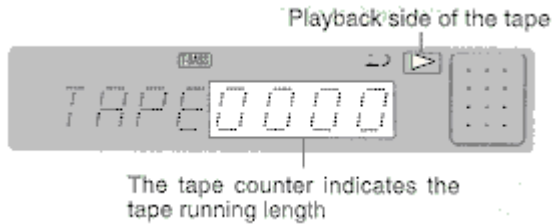

- ▷ : The front side is being played (forward).
- <◁ : The back side is being played (reverse).

To stop play, press ■ .

To pause play, press || . To resume play, press again.

To change the playback side, press ◀▶ **DIR/PRESET** in play or pause mode.

To fast forward or rewind, press ◀◀ or ▶▶ in stop mode.
Then press ■ to stop the tape.

To start play when the power is off (Direct Play Function)

Press **TAPES**. The power is turned on and play of the inserted tape begins.

To set the tape counter to 0000

Press ■ in stop mode.

The counter is also set to 0000 when the cassette holder is opened.

About cassette tapes

- **To prevent accidental erasure**, break off the plastic tabs on the cassette tape after recording with a screwdriver or other pointed tool.



To record on the tape again, cover the tab openings with adhesive tape, etc.

- **120-minute or longer tapes** are extremely thin and easily deformed or damaged. They are not recommended.
- **Take up any slack in the tape** with a pencil or similar tool before use. Slack tape may break or jam in the mechanism.

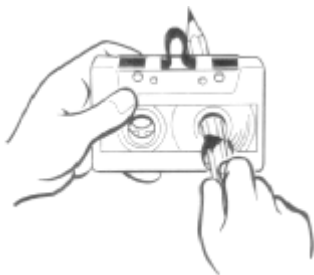

BASIC RECORDING

This section explains how to record from the tuner, CD player, or external equipment.

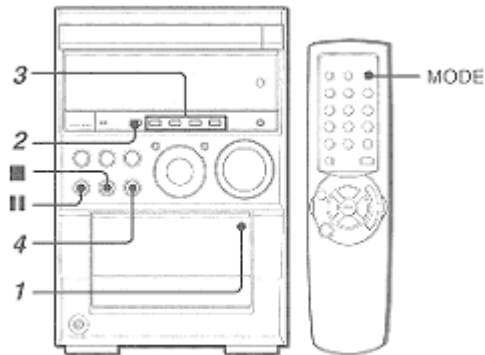

Preparation

- Use Type I (normal) tapes only.
- Set the tape to the point where recording will start.

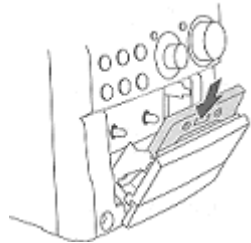

1 Insert the tape to be recorded on into deck.

Insert the tape with the side to be recorded on first facing out from the unit and the exposed side down.



2 Press TAPE/REV MODE to select the reverse mode.

To record on one side only, select .

To record on both sides, select  or .

3 Press function (TUNER, VIDEO/AUX or CD) and prepare the source to be recorded.

To record from a CD, press CD and load the disc.

To record from a radio broadcast, press TUNER/BAND and tune in to a station.

To record from a connected source, press VIDEO/AUX and play.

4 Press REC/REC MUTE to start recording.

When the selected function is CD, playback and recording start simultaneously.



To stop recording, press .

To pause recording, press  (applicable when the source is TUNER or VIDEO/AUX). To resume recording, press

it again.

Sound adjustment during recording

The output volume and tone of the speakers or headphones may be freely varied without affecting the recording.

INSERTING BLANK SPACE

Insertion of 4-second blank spaces may help you to locate the beginning of the track on other equipment. This unit can add 16 blank spaces only when the source is TUNER or VIDEO/AUX.

1 Press ● REC/REC MUTE during recording or while in recording pause mode.

REC on the display flashes for 4 seconds and the tape runs without recording. After 4 seconds, the deck enters the recording pause mode.

2 Press || to resume recording.

To insert a blank space of less than 4 seconds, press ● REC/REC MUTE again while REC is flashing.

To insert blank spaces of more than 4 seconds, after the deck enters the recording pause mode, press ● REC/REC MUTE again.

Each time ● REC/REC MUTE is pressed, a 4-second blank space is added.

**This unit does not have the function to locate the beginning of track.*

NOTE

Recording cannot be done when TAPE function is selected.

To erase a recording

1 Insert the tape to be erased into the deck.

2 Set the tape to the point where the erasure is to be started.

3 Set the reverse mode by pressing TAPE/REV MODE.

4 Press VIDEO/AUX and turn the connected equipment off.

5 Press ● REC/REC MUTE to start the erasure.

RECORDING (cont) pg. 13

AI EDIT RECORDING



The AI edit recording function enables CD recording without worrying about tape length and track length. When a CD is inserted, the unit automatically calculates the total track length. If necessary, the order of tracks is rearranged so that no track is cut short.

(AI: Artificial Intelligence)

NOTE

AI edit recording will not start from a point halfway into the tape. The tape must be recorded from the beginning of either side.

Use the remote control from steps 2 to 4.

1 Insert the tape into deck.

Insert the tape with the side to be recorded on first facing out from the unit.

2 Press FUNCTION repeatedly until "CD" is displayed and load the disc.**3 Press MODE repeatedly until "AI EDIT" appears on the display.**

"EDIT" lights up and "AI" flashes on the display.

**4 Press numbered buttons 0-9 to designate the tape length.**

10 to 99 minutes can be specified.

Example: When using a 60-minute tape, press **6** and **0**.

In a few seconds, the tracks to be recorded on each side of the tape are determined.

- ◀◀, ▶▶ or MULTI JOG are also available to designate the tape length.

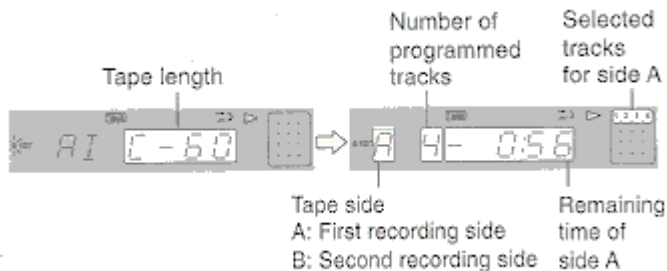
**5 Press ● REC/REC MUTE to start recording**

The tape is rewound to the beginning of the front side the lead segment is played through for 10 seconds, and recording starts. When recording on the front (side A) ends, recording on the back (side B) starts.

To stop recording

Press ■. Recording and CD play stop simultaneously.

To clear the edit program

Press ■ twice so that "EDIT" disappears on the display.

To check the order of the programmed track numbers

Before recording, press **MODE** to select side A or B, and press ◀◀ or ▶▶ repeatedly.

- MULTI JOG is also available instead of ◀◀ and ▶▶.

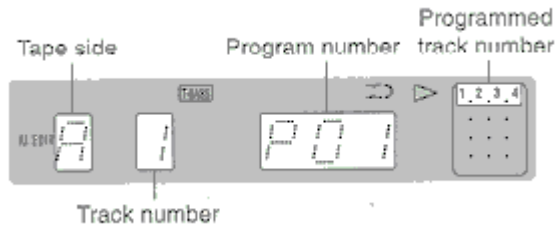

Time on cassette tapes and editing time

The actual cassette recording time is usually a little longer than the specified recording time printed on the label. This unit can program tracks to use the extra time. When the total recording time is a little longer than the tape's specified recording time after editing, the display shows the extra time (without a minus mark), instead of the time remaining on the tape (with the minus mark).

NOTE

- Recording is inhibited if the erasure prevention tab on either side of the tape is broken off.
- The AI edit function cannot be used with discs containing 31 tracks or more.

RECORDING (cont) pg. 14

PROGRAMMED EDIT RECORDING



In the programmed edit recording function, the track can be programmed while checking the remaining time on each side of the tape as the tracks are programmed.

NOTE

The programmed edit recording will not start from a point halfway in the tape. The tape must be recorded on from the beginning of either side.

Use the remote control from step 2 to 7.

1 Insert the tape into deck.

Insert the tape with the side to be recorded on first facing out from the unit.

2 Press FUNCTION repeatedly until "CD" is displayed and load the disc.

3 Press MODE repeatedly until "PRGM EDIT" appears on the display.

"EDIT" lights up and "PRGM" flashes on the display.



4 Press numbered buttons 0-9 to designate the tape length.

10 to 99 minutes can be specified.

Example: When using a 60-minute tape, press **6** and **0**.

- ◀◀, ▶▶ or MULTI JOG are also available to designate the tape length.

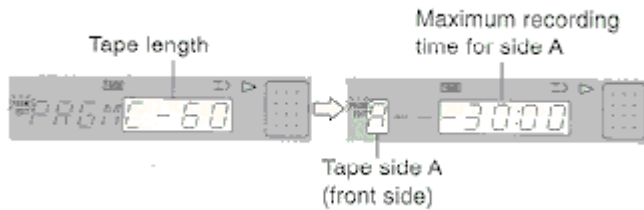

5 Press the numbered buttons 0-9 and +10 to program a track.

Example: To select the 10th track, press **+10** and **0**.

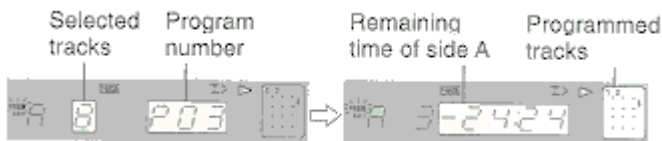

6 Repeat step 5 for the rest of the tracks for side A.

A track whose playing time is longer than the remaining time cannot be programmed.

7 Press MODE to select side B and program the tracks for side B.

After confirming "B" on the display, repeat step 5.



8 Press ● REC/REC MUTE to start recording.

The tape is rewound to the beginning of the front side, the lead segment is played through for 10 seconds, and recording starts. When recording on the front (side A) ends, recording on the back (side B) starts.

To stop recording

Press ■. Recording and CD play stop simultaneously.

To check the order of the programmed track numbers

Before recording, press **MODE** to select side A or B, and press ◀◀ or ▶▶ repeatedly.

- ◀◀, ▶▶ or MULTI JOG are also available to designate the tape length.

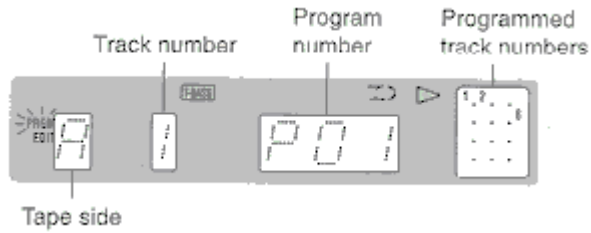

To change the program of each side

Press **MODE** to select side A or B, and press **■** to clear the program on the selected side. Then program tracks again.

To clear the edit program

Press **■** twice so that "EDIT" disappears on the display.

NOTE

- Recording is inhibited if the erasure prevention tab on either side of the tape is broken off.
- Up to 30 tracks can be programmed from anyh of the inserted disc.

CLOCK AND TIMER pg. 15

SETTING THE CLOCK

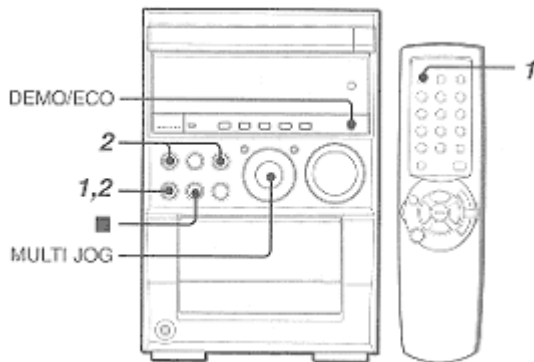

Set the clock during power on.

1 Press DISPLAY on the remote control and press **|| within 4 seconds.**

The display flashes.



2 Press **◀◀ or **▶▶** to designate the time, then press **||**.**

Each time **◀◀** or **▶▶** is pressed the time changes by 1 minute. To change the time by 30 minutes, press and hold down **◀◀** or **▶▶**.

- MULTI JOG is also available instead of **◀◀** and **▶▶**.

To display the current time

With power on, press **DISPLAY** once on the remote control. The time is displayed for 4 seconds.

However, the time cannot be displayed during recording.

When the power is off, press **DEMO/ECO** repeatedly until the display changes to clock or press **||** once (the time is displayed for 4 seconds).

To switch to the 24-hour standard

With power on, press **DISPLAY** then press **■** within 4 seconds. Repeat the same procedure to restore the 12-hour standard.

If the clock display flashes

This is caused by a power interruption. The current time needs to be reset.

If power is interrupted for more than approximately 24 hours, all settings stored in memory after purchase need to be reset.

NOTE

After finish setting the clock, the unit will switch to ECO mode.

SETTING THE SLEEP TIMER

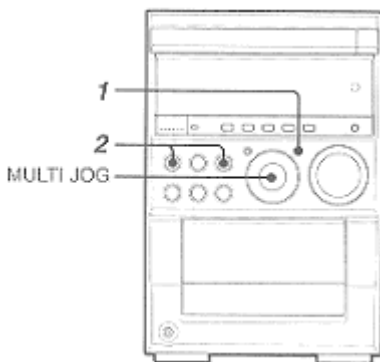

The unit can be turned off automatically at a specified time.

1 Press **SLEEP**.



2 Within 3 seconds, press **◀◀** or **▶▶** to specify the time until the power is turned off.

The time changes between 5 and 240 minutes in 5-minute steps.

- **MULTI JOG** is also available instead of **◀◀** and **▶▶**.



To check the time remaining until the power is turned off

Press JOG MODE repeatedly until "SLEEP" is displayed. The remaining time is displayed for 3 seconds.

To cancel the sleep timer

Press JOG MODE repeatedly until "SLEEP" is displayed, then turn MULTI JOG within 3 seconds so that "SLEEPoFF" appears on the display.

CLOCK AND TIMER (cont.) pg. 16

SETTING THE TIMER

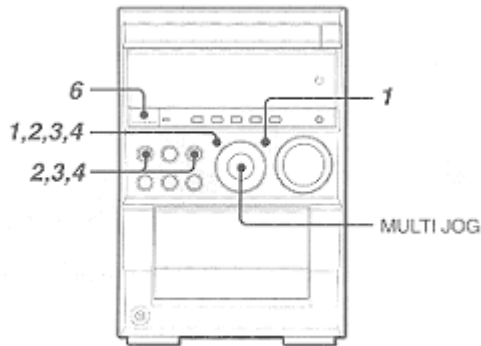

The unit can be turned on at a specified time every day with the built-in timer.

Preparation

Make sure the clock is set correctly. (See page 15).

1 Press JOG MODE repeatedly until "⊕" is displayed, then turn MULTI JOG within 2 seconds until "⊕" appears on the display. Then press ENTER within 6 seconds.

The time flashes.



NOTE

If you press **ENTER** after 6 seconds, another operation may start.

2 Designate the timer-on time by pressing ◀◀ or ▶▶ then press ENTER.

To change the timer-on time by 30 minutes, press and hold down ◀◀ or ▶▶.

• MULTI JOG is also available instead of ◀◀ and ▶▶.

After you designate the timer-on time, one of the source names flashes on the display.



3 Press ◀◀ or ▶▶ to select a source, then press ENTER.

- If TUNER is pressed, the band cannot be selected in this step.
- MULTI JOG is also available instead of ◀◀ and ▶▶.

After you select a source, the duration for the timer-activated period flashes on the display.



4 Select the duration for the timer-activated period with ◀◀ or ▶▶, then press ENTER.

The duration for the timer-activated period can be set between 5 and 240 minutes in 5-minute steps.

- MULTI JOG is also available instead of ◀◀ and ▶▶.

5 Prepare the source.

To listen to a CD, load the disc.

To listen to a tape, insert the tape into deck.

To listen to the radio, tune in to a station.

6 Press POWER to turn the unit off after adjusting the volume and tone.

When the timer-on time is reached, the unit turns on and begins play with the selected source.

The volume level is automatically set to 20 when the power is turned off with the volume level set to 21 or more.

To check the specified time and source

Press JOG MODE repeatedly until "⌚" is displayed. The timer-on time, the selected source name and the duration for the timer-activated period flash alternately for 6 seconds.

To cancel timer standby mode temporarily

Press JOG MODE repeatedly until "⌚" is displayed, then turn MULTI JOG within 6 seconds until "⌚" or "⌚ REC" disappears on the display.

To restore the timer standby mode, press JOG MODE repeatedly until "⌚" is displayed, then turn MULTI JOG within 2 seconds to display "⌚" or "⌚ REC".

Using the unit while the timer is set

You can use the unit normally after setting the timer.

Before turning off the power, carry out step 5 to prepare the source, and adjust the volume and tone.

NOTE

- Timer playback and timer recording will not begin unless the power is turned off.
- Connected equipment cannot be turned on and off by the built-in timer of this unit. Use an external timer.

TIMER RECORDING

Timer recording is applicable for TUNER and VIDEO/AUX (with an external timer) sources only.

Press JOG MODE repeatedly until "⌚" is displayed, then turn MULTI JOG within 2 seconds until "⌚ REC" appears on the display. Then press ENTER within 6 seconds.

Carry out the steps of "SETTING THE TIMER" from step 2 and insert the tape to be recorded into deck after step 5.

CONNECTING OPTIONAL EQUIPMENT

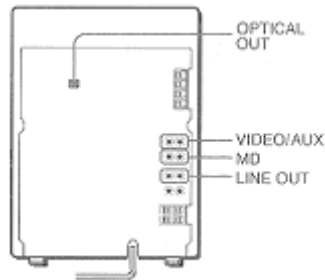

Refer to the operating instructions of the connected equipment for details.

- The connecting cords are not supplied. Obtain the necessary connecting cords.
- Consult your local Aiwa dealer for optional equipment.

VIDEO/AUX JACKS

This unit can input analog sound signals through these jacks. Use a cable with RCA phono plugs to connect audio equipment (turntables, LD players, VCRs, etc.).

Connect the red plug to the **VIDEO/AUX R** jack, and the white plug to the **VIDEO/AUX L** jack.

When connecting a turntable

Use an Aiwa turntable equipped with a built-in equalizer amplifier.

MD JACKS

This jack is recommended to connect with an MD player.

Use a cable with RCA phono plugs.

Connect the red plug to the **MD R** jack, and the white plug to the **MD L** jack.

- When MD player is connected to these jacks, no sound will be output from the **LINE OUT** jacks.

LINE OUT JACKS

This unit can output analog sound signal through these jacks.

Use a cable with RCA phono plugs to connect audio equipment with **LINE IN** (analog input) jacks.

Connect the red plug to **LINE OUT R** jack and the white plug to **LINE OUT L** jack.

NOTE

Do not connect an equipment to **LINE OUT** and **VIDEO/AUX** simultaneously. Otherwise, noise is generated and malfunction occurs.

OPTICAL OUT JACK

This unit can output CD digital sound signals through this jack. Use an optical cable to connect digital audio equipment (DAT deck, MD recorder, etc.).

Remove the dust cap (a) from the **OPTICAL OUT** jack. Then, connect an optical cable plug to the **OPTICAL OUT** jack.

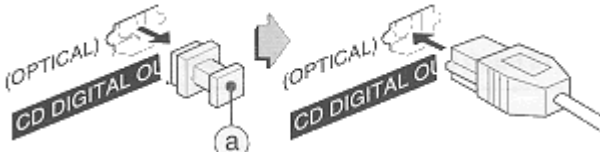

When the OPTICAL OUT jack is not being used
Attach the supplied dust cap.

LISTENING TO EXTERNAL SOURCES



To play equipment connected to the **VIDEO/AUX** jacks, proceed as follows.

1 Press VIDEO/AUX or MD.

To play the equipment connected to VIDEO/AUX jacks, press VIDEO/AUX. "AUX" appears on the display.
To play the equipment connected to MD jacks, press MD. "MD" appears on the display.

2 Play the connected equipment.

To change a source name in the display

When **VIDEO/AUX** is pressed, "AUX" is displayed initially. It can be changed to "TV" or "VIDEO".
With the power on, press **POWER** while pressing **VIDEO/AUX**.
Repeat the procedure to select one of the source names.

GENERAL pg. 18

CARE AND MAINTENANCE

Occasional care and maintenance of the unit and the software are needed to optimize the performance of your unit.

To clean the cabinet

Use a soft and dry cloth.

If the surfaces are extremely dirty, use a soft cloth lightly moistened with mild detergent solution. Do not use strong solvents, such as alcohol, benzine or thinner as these could damage the finish of the unit.

To clean the heads and tape paths

After every 10 hours of use, clean the heads and tape paths with a head cleaning cassette or cotton swab moistened with cleaning fluid or denatured alcohol. (These cleaning kits are commercially available.)

When cleaning with a cotton swab, wipe the recording/playback head, erasure head, capstans, and pinchrollers.

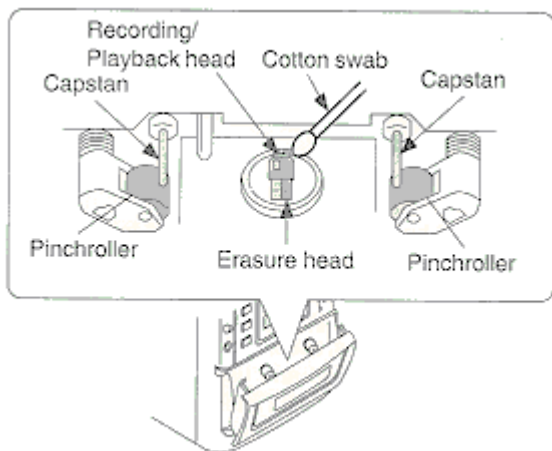

After cleaning the heads and tape paths with a liquid head cleaning cassette or a moistened swab, wait until the cleaned parts are completely dry before inserting the tapes.

To demagnetize the heads

The heads may become magnetized after long-term use. This may narrow the output range of recorded tapes and increase noise. After 20 to 30 hours use, demagnetize the heads with any commercially available demagnetizer.

Care of discs

- When a disc becomes dirty, wipe the disc from the center out with a cleaning cloth.
- After playing a disc, store the disc in its case. Do not leave the disc in places that are hot or humid.



Care of tapes

- Store tapes in their cases after use.
- Do not leave tapes near magnets, motors, television sets, or any source of magnetism. This will downgrade the sound quality and cause noise.
- Do not expose tapes to direct sunlight, or leave them in a car parked in direct sunlight.

TROUBLESHOOTING GUIDE

If the unit fails to perform as described in these Operating Instructions, check the following guide.

GENERAL

There is no sound.

- Is the AC cord connected properly?
- Is there a bad connection? (--> page 3)
- There may be a short circuit in the speaker terminals.
--> Disconnect the AC cord, then correct the speaker connections.
- Was an incorrect function button pressed?

Sound is emitted from one speaker only.

Is the other speaker disconnected?

An erroneous display or a malfunction occurs.

--> Reset the unit as stated below.

TUNER SECTION

There is constant, wave-like static.

- Is the antenna connected properly? (--> page 4)
- Is the signal weak?

--> Connect an outdoor antenna.

The reception contains noise interferences or the sound is distorted.

- Is the system picking up external noise or multipath distortion?

--> Change the orientation of the antenna.

--> Move the unit away from other electrical appliances.

CASSETTE DECK SECTION

The tape does not run.

- Is deck in pause mode? (--> page 11)

The sound is off-balance or not adequately high.

- Is the playback head dirty? (--> page 18)

Recording is not possible.

- Is the erasure prevention tab on the tape broken off? (--> page 11)

- Is the recording head dirty? (--> page 18)

Erasure is not possible.

- Is the erasure head dirty? (--> page 18)

- Is a metal tape being used?

High frequency sound is not emitted.

- Is the recording/playback head dirty? (--> page 18)

CD PLAYER SECTION

The CD player does not play.

- Is the disc correctly placed? (--> page 9)

- Is the disc dirty? (--> page 18)

- Is the lens affected by condensation?

--> Wait approximately one hour and try again.

To reset

If an unusual condition occurs in the display window or the cassette decks, reset the unit as follows.

1 Press **POWER** to turn off the power.

2 Press **POWER** to turn the power back on while pressing **■**.

Everything stored in memory after purchase is canceled.

If the power cannot be turned off in step 1 because of a malfunction, reset by disconnecting the AC cord, and connect it again. Then carry out step 2.

GENERAL (cont) pg. 19

SPECIFICATIONS

Main unit XR-M55

FM tuner section

Tuning range. 87.5 MHz to 108 MHz
Usable sensitivity (IHF). 13.2 dBf
Antenna terminals. 75 ohms (unbalanced)

AM tuner section

Tuning range. 530 kHz to 1710 kHz (10 kHz step)
. 531 kHz to 1602 kHz (9 kHz step)
Usable sensitivity. 350 μ V/m
Antenna. Loop antenna

Amplifier section

Mid-high frequency amplifier

Power output. 8 W + 8 W (200 Hz - 20 kHz, THD less than 1%, 6 ohms)
Total harmonic distortion. 0.15% (5 W, 1 kHz, 6 ohms, DIN AUDIO)

Low frequency amplifier

Power output. 22 W + 22 W (35 Hz - 200 Hz, THD less than 1%, 6 ohms)
Total harmonic distortion. 0.15 % (12.5 W, 75 Hz, 6 ohms, DIN AUDIO)

Inputs. VIDEO/AUX: 0.4 V
. MD: 0.4 V

Outputs. LINE OUT: 150 mV (47 kohms load)

. SPEAKERS HIGH FREQ: accept speakers of 6 ohms or more

. SPEAKERS LOW FREQ: accept speakers of 6 ohms or more

. PHONES (stereo minijack): accepts headphones of 32 ohms or more

Cassette deck section

Track format. 4 tracks, 2 channels stereo

Frequency response. CrO2 TAPE: 50 Hz to 16000 Hz

. Normal tape: 50 Hz - 15000 Hz

Signal-to-noise ratio. 50 dB (CrO2 tape peak level above 1 kHz)

Recording system. AC bias

Heads. Recording/playback head x 1

. Erase head x 1

Compact disc player section

Laser. Semiconductor laser ($\lambda=780$ nm)

D-A converter. 1 bit dual

Signal-to-noise ratio. 75 dB (1 kHz, 0 dB)

Harmonic distortion. 0.1 % (11 kHz, 0 dB)

Wow and flutter. Unmeasurable

General

Power requirements. AC: 120 V, 60 Hz

Power consumption. 75 W

Dimensions of main unit. 175 x 259 x 292 mm

(W x H x D). (7 x 10 1/4 x 11 1/2 in)

Weight of main unit. 5.5 kg

. (12 lbs 2 oz)

Standby power consumption. If the power economizing mode is on: 1.5 W

. If the power economizing mode is off: 11 W

Speaker system

Cabinet type.....	3 way, built in subwoofer (magnetic shield type)
Speakers.....	Subwoofer: 130 mm (5 1/8 in) cone type
.....	Full range: 100 mm (4 in) cone type
.....	Super tweeter: 20 mm (13/16 in) ceramic type
Impedance.....	.6 ohms, 8 ohms
Output sound pressure level.....	86 dB/W/m
Dimensions (W x H x D).....	165 x 260 x 265 mm
.....	(6 1/2 x 10 1/4 x 10 1/2 in)
Weight.....	.4.1 kg
.....	(.9 lbs 1 oz)

Specifications and external appearance are subject to change without notice.

COPYRIGHT

Please check the laws on copyright relating to recordings from discs, radio or external tape for the country in which the machine is being used.

NOTE

This equipment has been tested and found to comply with the FCC limits for a Class B digital device, pursuant to Part 15 of the Rules. These limits are designed to provide reasonable protection against harmful interference in a residential installation. This equipment generates, uses, and can radiate radio frequency energy and, if not installed and used in accordance with the instructions, may cause harmful interference to radio communications. However, there is no guarantee that interference will not occur in a particular installation. If this equipment does cause harmful interference to radio or television reception, which can be determined by turning the equipment off and on, the user is encouraged to try to correct the interference by one or more of the following measures:

- Reorient or relocate the receiving antenna.
- Increase the separation between the equipment and receiver.
- Connect the equipment into an outlet on circuit different from that to which the receiver is connected.
- Consult the dealer or an experienced radio/TV technician for help.

CAUTION

Modifications or adjustments to this product, which are not expressly approved by the manufacturer, may void the user's right or authority to operate this product.

GENERAL (cont.) pg. 20

PARTS INDEX

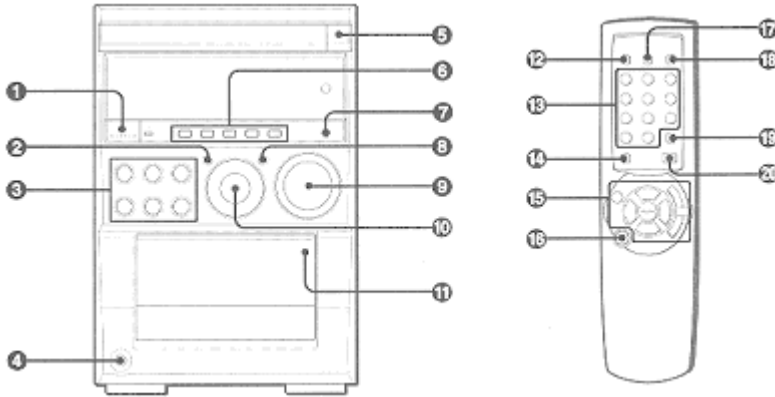

Name	Page	
1	Power	5, 8, 16-18
2	Enter	16
3	Tuning down	8-11, 13-16
	Dir/Preset	8-11
	Tuning up	8-11, 13-16
	Set	8, 9, 11, 12, 15
	Clear	8-15
	Rec/Rec Mute	12-14
4	Phones	5
5	Open/Close	9
6	Tape/Rev mode	11, 12
	Tuner/Band	8
	Video/Aux	17
	CD	9
	MD	17
7	Demo/Eco	5, 6, 15
8	Jog mode	7, 15, 16
9	Volume	7
10	Multi jog	7-10, 13-16
11	Push eject	11
12	Display	7, 9, 15
13	0-9, +10	8-10, 13, 14
14	Band	8
15	Pause	8, 9, 11, 12, 15
	Skip/Search	8-11, 13-16
	Play	5, 10
	Skip/Search	8-11, 13-16
	Stop	8-15
	Vol (∧, ∨)	7
16	Power	5, 16
17	EQ	7
18	Mode	8-14
19	Repeat	10
20	Function	5, 13, 14